

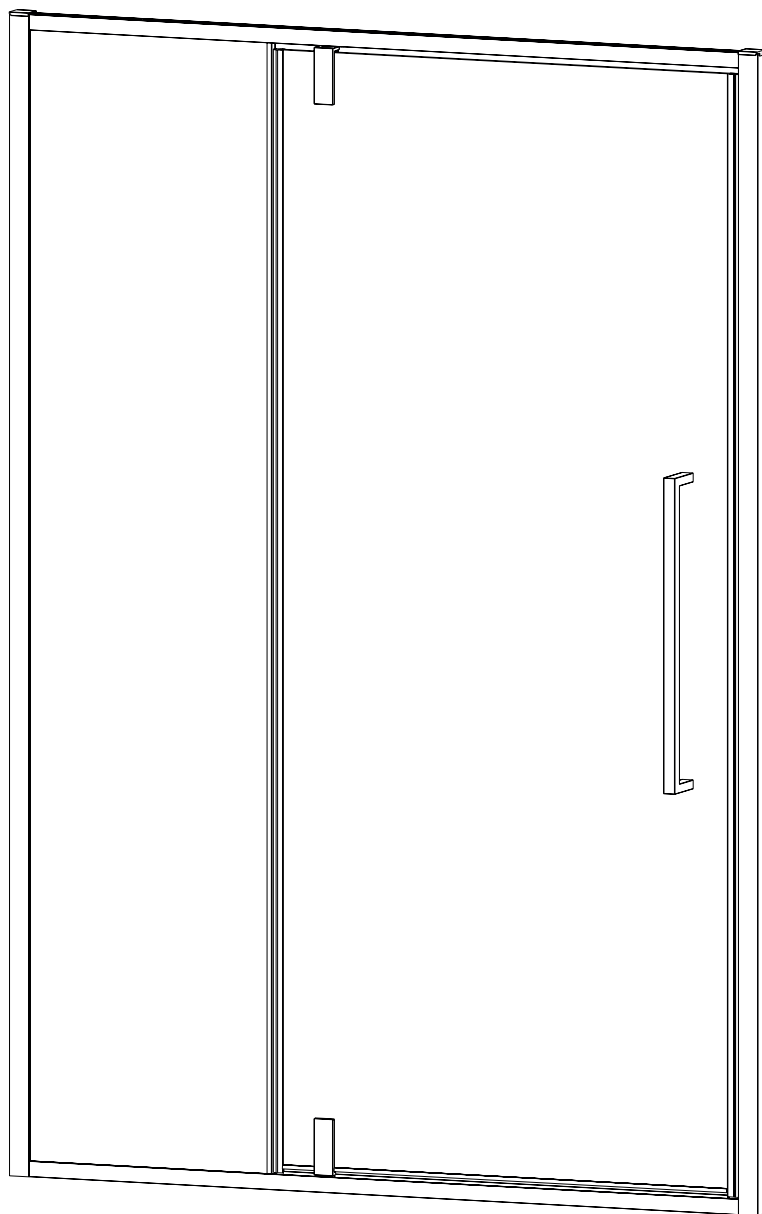

Душевая дверь

VN-34/34B



Инструкция по установке

Пожалуйста, прочитайте инструкцию перед установкой

 Перед установкой поддон для душа должен быть выставлен по уровню и полностью герметичным к плитке.

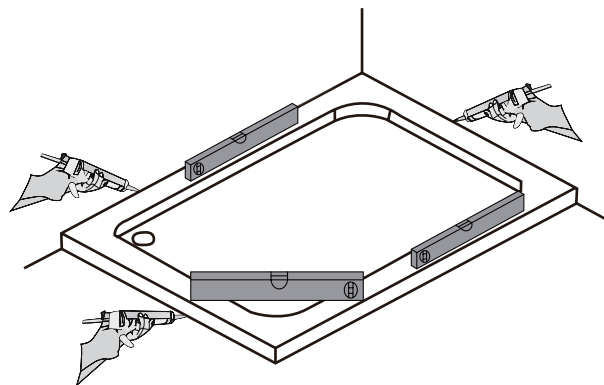

Необходимые инструменты и оборудование



Карандаш

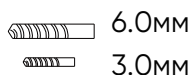

Сверло



Отвертка

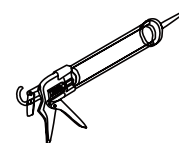

Силикон

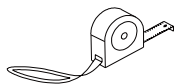

Рулетка

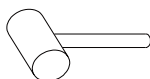

Молоток



Уровень



Дрель

Данная модель с универсальной установкой открывания двери

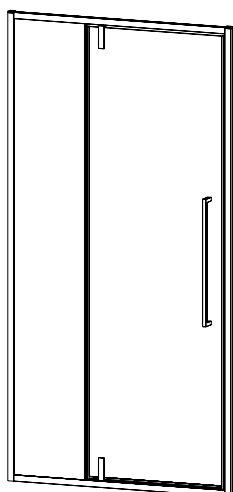

Левая ориентация

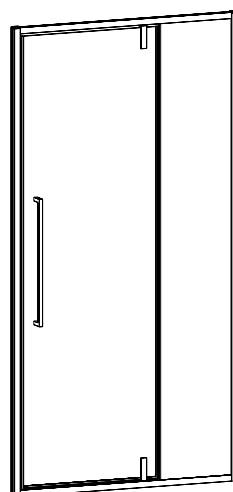

Правая ориентация

Общий вид душевого угла

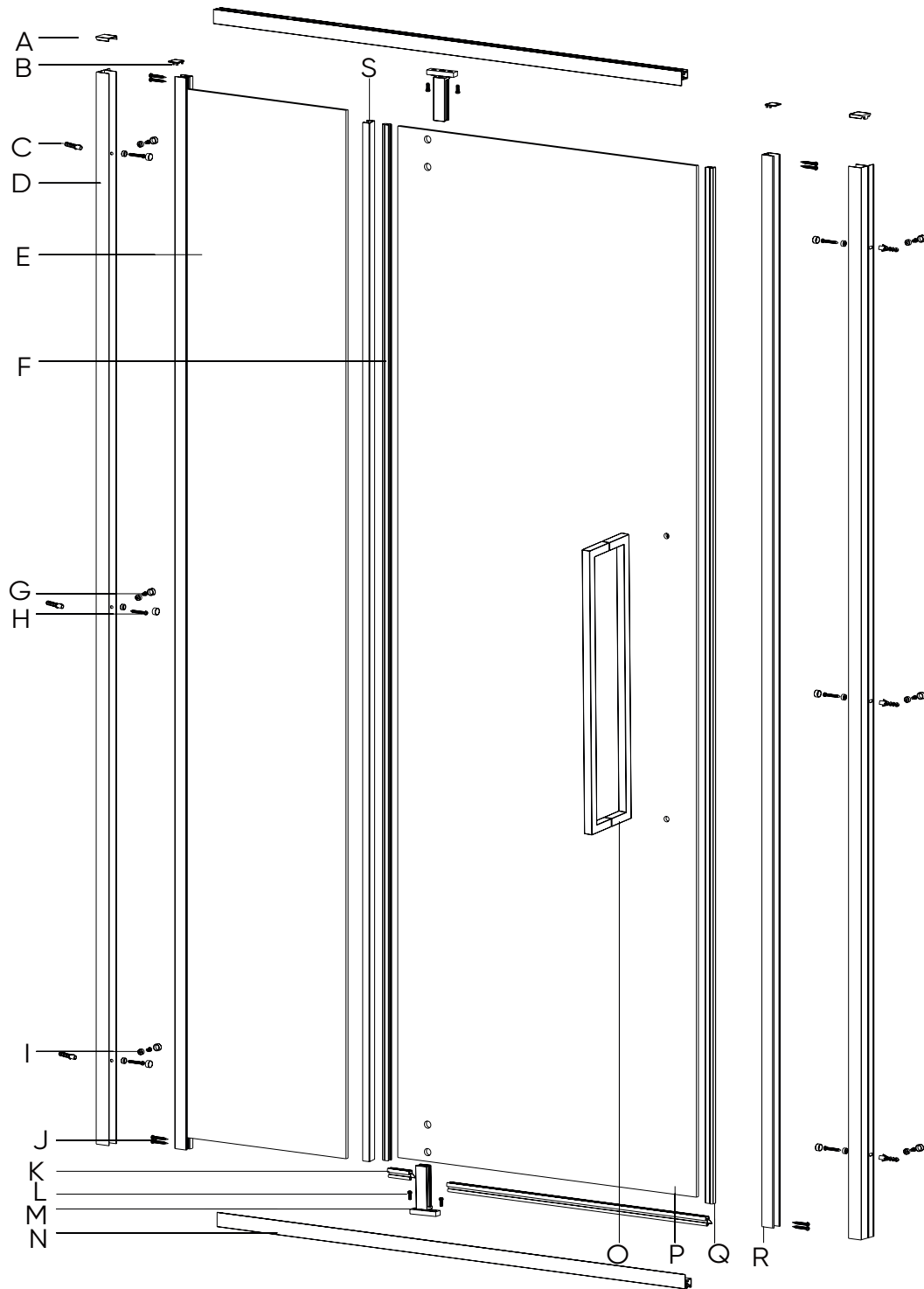

Перечень деталей

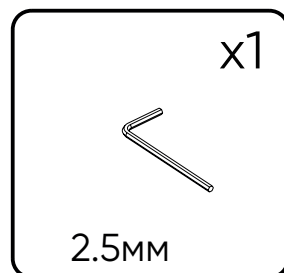
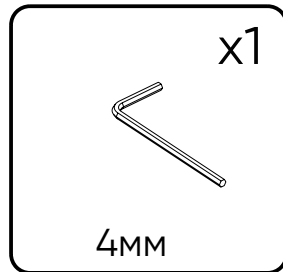
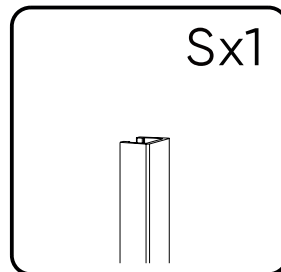
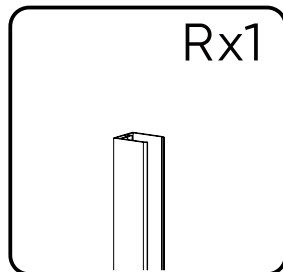
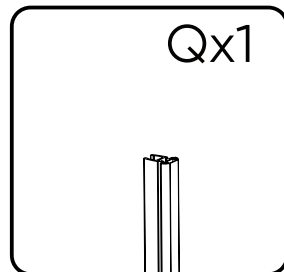
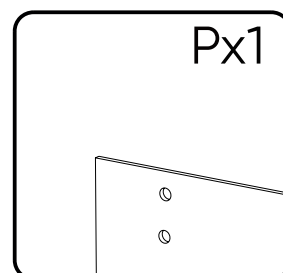
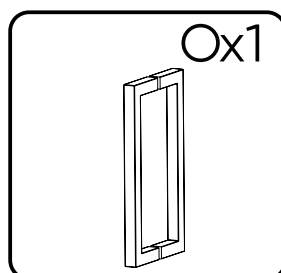
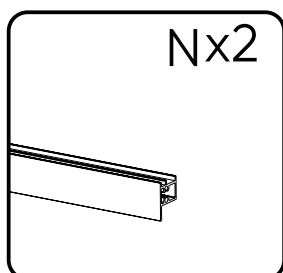
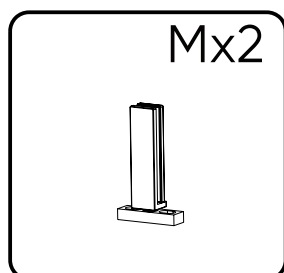
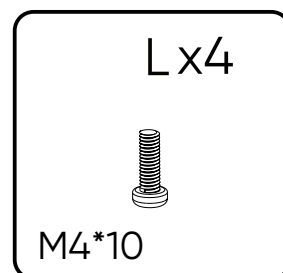
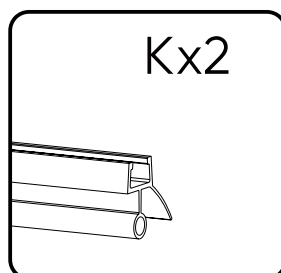
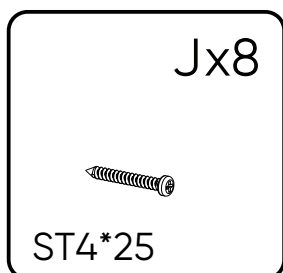
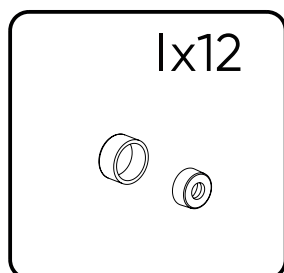
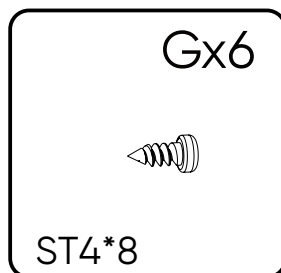
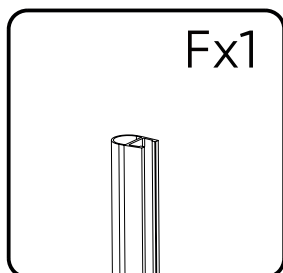
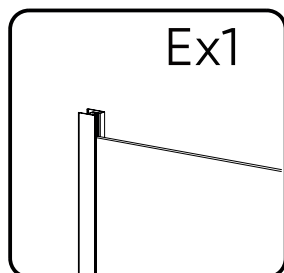
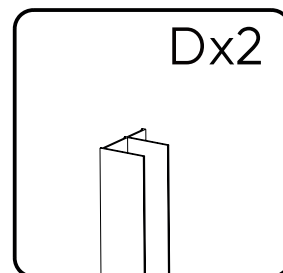
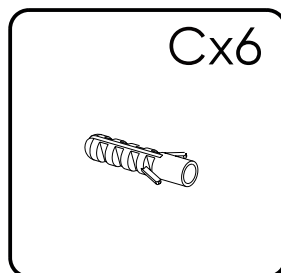
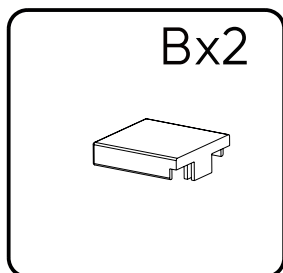
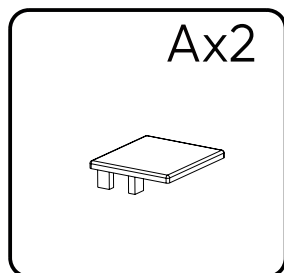

Шаг 1

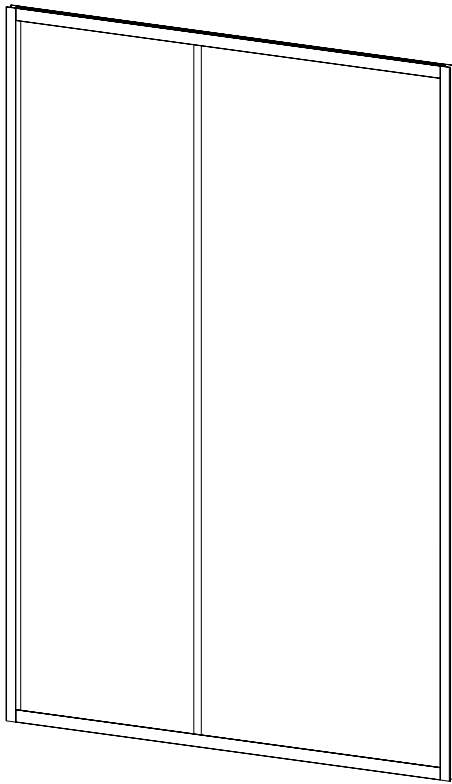

Артикул	Регулировка(мм)
VN34/34B-100-01-C7	990-1010
VN34/34B-110-01-C7	1090-1110
VN34/34B-120-01-C7	1190-1210

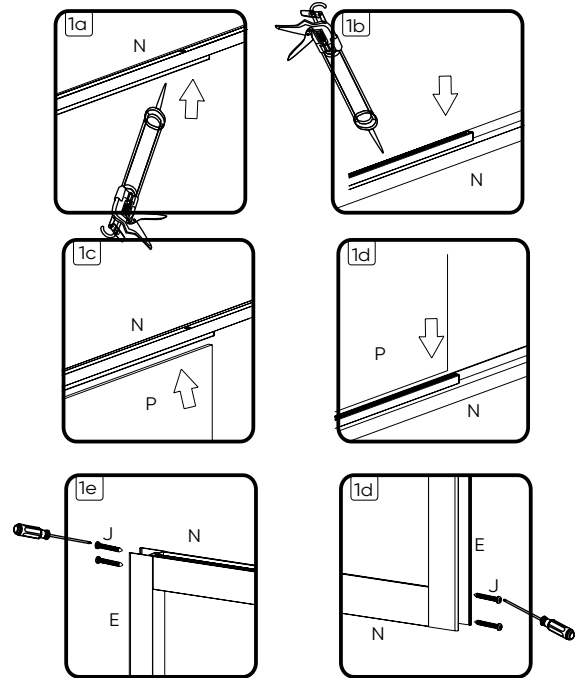

Шаг 2

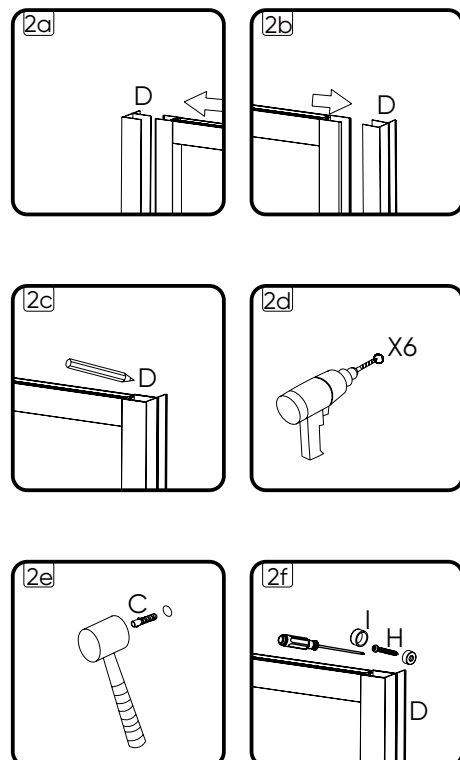
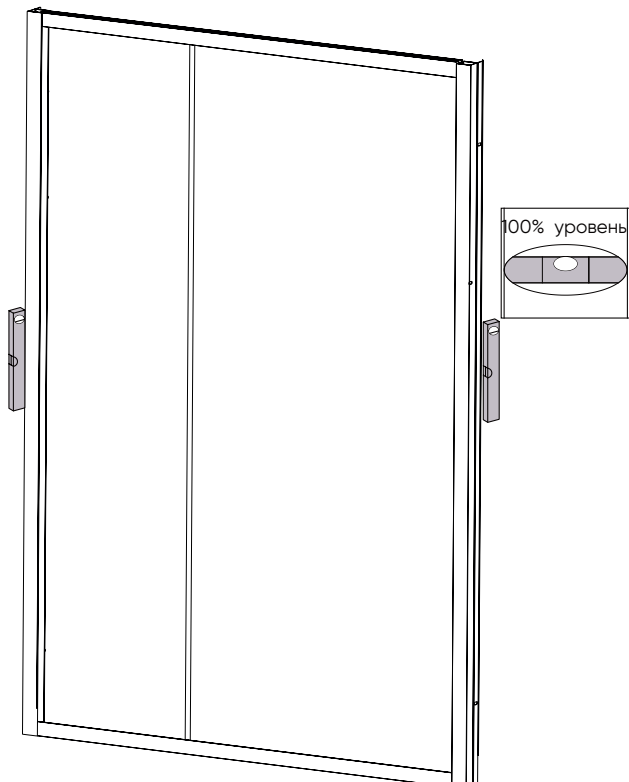

Шаг 3

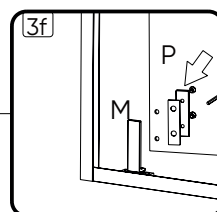
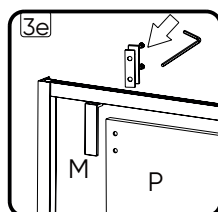
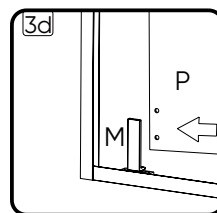
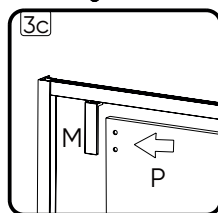
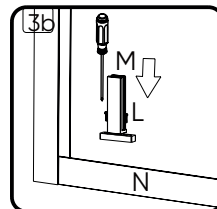
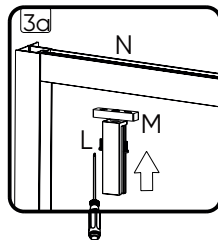
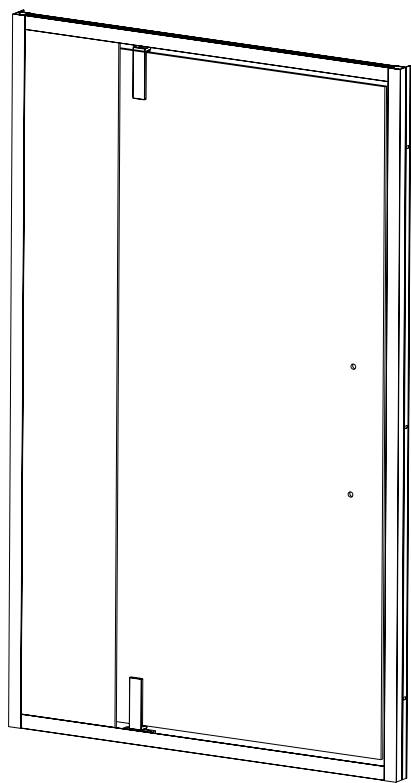

Шаг 4

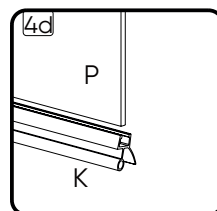
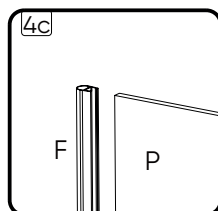
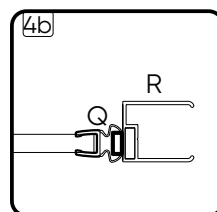
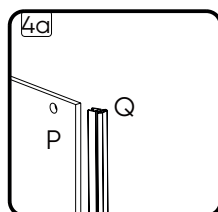
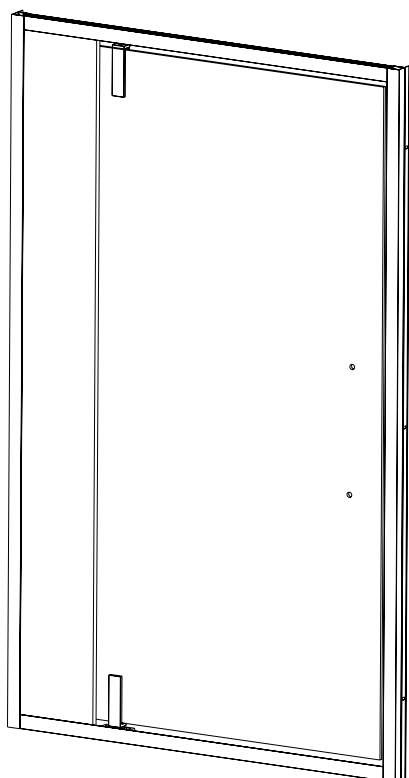

шаг 5

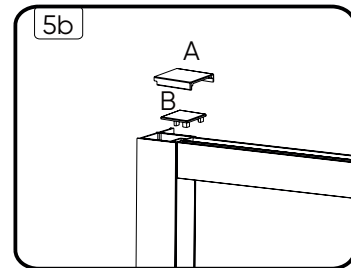
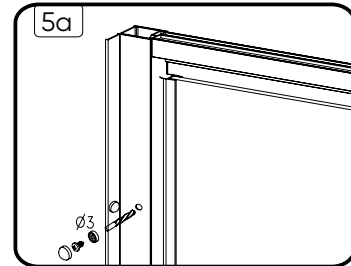
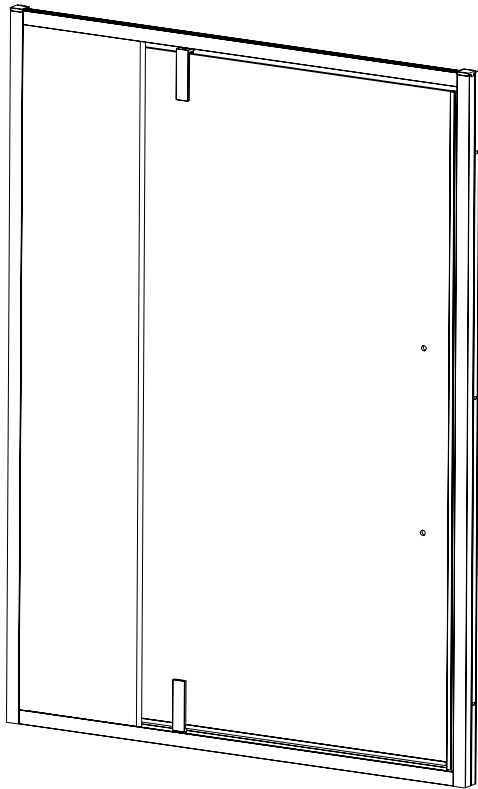

шаг 6

