

PREDINSTALACIJA  
PREDINSTALACIJA

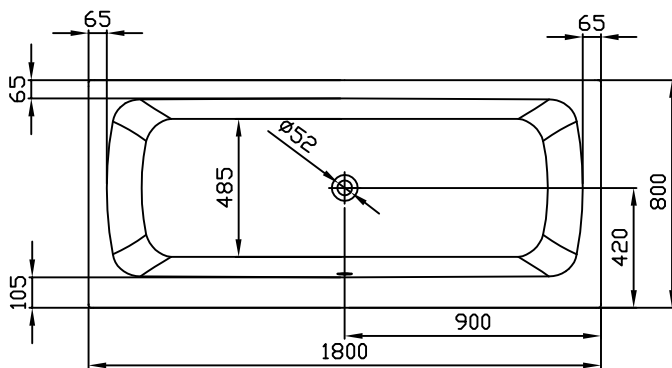
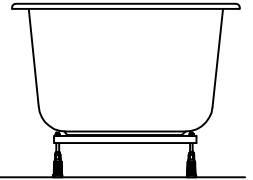
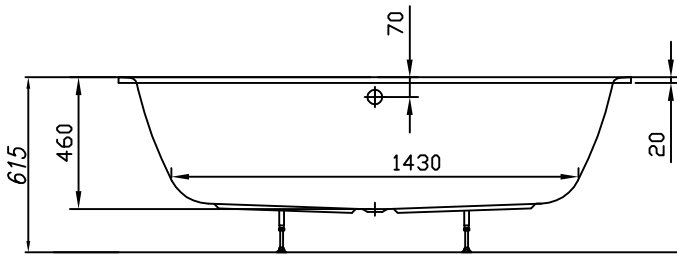
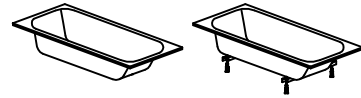

VOLUMEN (l)  
VOLUMEN (l)

MAX. OBREMENITEV (Kg)  
MAX. OBTEREČENJE (Kg)

OBREMENITEV TAL (Kg/m<sup>2</sup>)  
OBTEREČENJE PODA (Kg/m<sup>2</sup>)

260

400

280

- - Prostor za el. vodnik 3 x 2,5 mm<sup>2</sup>, dolžine cca 1m.
- - Mjesto za el. vodnik 3 x 2,5 mm<sup>2</sup>, dužine cca 1m.
- - Prostor za el. vodnik 1 x 6 mm<sup>2</sup> za ozemljitev, dolžine cca 1,5m.
- - Mjesto za el. vodnik 1 x 6 mm<sup>2</sup> za ozemljenje, dužine cca 1,5m.
- ⚡ - Priklop tople in hladne vode 1/2" min 0,2 Mpa, max 0,4 Mpa
- ⚡ - Priključak tople i hladne vode 1/2" min 0,2 Mpa, max 0,4 Mpa
- - Prostor za odtok ø 50 mm
- - Mjesto za odtok ø 50 mm



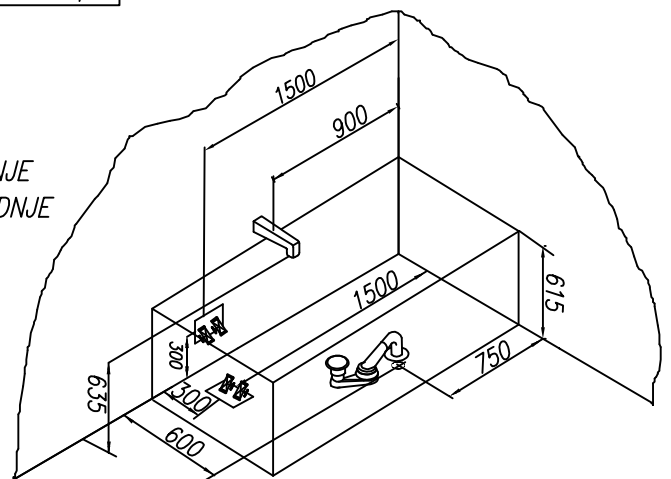



PREDLOG VGRADNJE  
PRIJEDLOG UGRADNJE



Priporočena prelivna garnitura Preporuka prelivne garniture	PAL 650
Priporočila za vgradnjo kadi brez obloge Preporuka za ugradnjo kade bez obloge	Nr. MK 05
Opcija podnožja kadi za vgradnjo Varianta postolja za kade bez obloge	Nr. MK 10 PKK 501

BELL-E2 180x80

POLOŽAJ STIKAL IN AGREGATOV PRI RAZLIČNIH IZVEDBAH MASAŽNIH SISTEMOV  
MJESTO PREKIDAČA I AGREGATA KOT RAZLIČITIH IZVEDBI MASAŽNIH SISTEMA

- |  |  |   |  |  |
|--|--|---|--|--|
|  - VODNA ČRPALKA<br>- CRPKA ZA VODU        |  - VODNE ŠOBE<br>- VODENE MLAZNICE  |  - REGULATOR ZRAKA<br>- REGULATOR ZRAKA        |  - ELEKTRONSKA STIKALA<br>- ELEKTRONSKI PREKIDAČI         |  - ARMATURA IN TUŠ ROČICA<br>- PIPA I TUŠ                 |
|  - ZRAČNI KOMPRESOR<br>- ZRAČNI KOMPRESOR |  - ZRAČNA ŠOBA<br>- ZRAČNA MLAZNICA |  - PNEVMATSKO STIKALO<br>- PNEVMATSKI PREKIDAČ |  - LUČ ALI CHROMOTERAPIJA<br>- SVJETLO ILI CHROMOTERAPIJA |  - PREKLOPNIK ZA MIKROŠOBE<br>- PREKIDAČ ZA MIKROMLAZNICE |

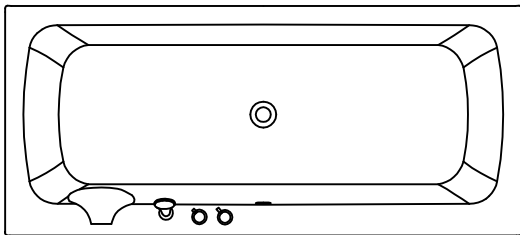

- OPCIJA ARMATURA IN TUŠ ROČICA - OPCIJA PIPA I TUŠ